

FH-M



IP66
IK09
960°
SD DERATING +60°C -30°C
RD +40°C -20°C
EMERGENCY +40°C 0°C

- Outdoor floodlight with goniometric fixing bracket. Luminous flux up to over 17000 lm.
- Available in Smart Driver Auto-dimmable version, controllable from the Central Unit, or with an RD system that has a selector to set 4 steps of luminous flux.
- Double aluminium high bay light, both symmetrical and asymmetrical (by removing the deflector).

Applications

Industry, services, civil

Characteristics

Power supply

SD 93÷265 VAC - 50/60Hz 176÷250 VDC

RD 230VAC ±10% 50 Hz

Power supply - MTBF at 25°C 100,000 h

Luminous flux retention at 25°C

>60,000h (110W and 100W) (L80B20)

>70,000h (75W) (L80B20)

>80,000h (50W) (L80B20)

Colour stability 3 SDCM

Mounting Floor, wall, lighthouse towers, suspended, ceiling

Housing Polyester powder-coated die-cast aluminium, RAL 7040

Optics Parabolic blades, made of anti-iridescent polished anodised aluminium. Symmetrical, asymmetrical.

Screen Tempered glass prism, 4mm

Compliance EN 60598-1, EN 60598-2-1, EN 60598-2-22, DIN 18031-3, EN 62471 (photobiological risk-free), 2014/53/EU

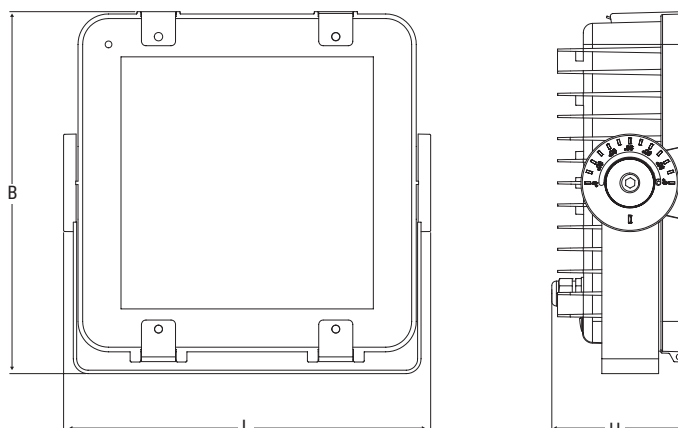

Dimensions mm		
L	B	H
323	319	116

FH-M ASYMMETRIC OPTICS

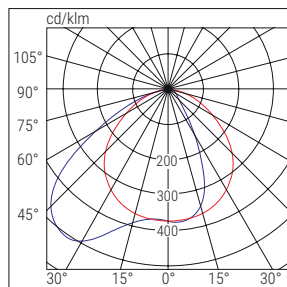

■ C90-C270 ■ C0-C180

FH-M SYMMETRIC OPTICS

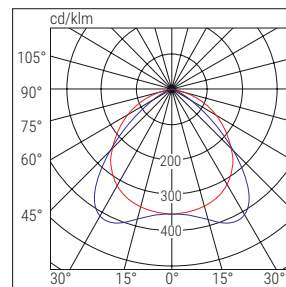

■ C90-C270 ■ C0-C180

	Order Code	Description	Optics	Power W	Colour temp. K	Chromatic yield	LED Flux lm (Tj=25°C)	Luminaire flux lm	Brightness efficiency lm/W	Weight Kg	Packaging Single/ Multi pack	
SD	40807	PRO/RIF 75W SD 4K	Symmetrical/asymmetrical	74	4000	>80	12000	11984	162	4	1	AUTO-DIMMER
	40810	PRO/RIF 110W SD 4K	Symmetrical/asymmetrical	110	4000	>80	18000	16800	153	4	1	
RD	40801	PRO/RIF 50W ADJUSTABLE 4K	Symmetrical/asymmetrical	50	4000	>80	7800	7430	149	4	1	ADJUSTABLE
	40804	PRO/RIF 100W ADJUSTABLE 4K	Symmetrical/asymmetrical	100	4000	>80	15600	14073	141	4	1	

DALI **MODULAR ENCODING:**
 To create the DALI version device code, select a device in the range **RD** and add to its code the suffix **DL**
 Example: Order Code **40801 + DL** = Order Code **40801DL** - NOTE: The power of these luminaires, in the DALI version, is increased as compared to the version **RD**: Order Code 40801DL = 74W; Order Code

RD VERSIONS, MANUALLY ADJUSTABLE FLUX/POWER AT 4 STEPS



Flux/Power	Code 40801			Code 40804		
	lm	W	lm/W	lm	W	lm/W
STEP 1	7430	50	149	14073	100	141
STEP 2	6496	42	155	12464	84	148
STEP 3	5586	35	160	10777	70	154
STEP 4	4561	28	163	8893	56	159

The lighting system must consider both the required level of lighting obtained from the lighting calculation and the power saving needs. The FH-M floodlight allows you to achieve this result thanks to its driver equipped with a 4-step current modulation switch that provides maximum luminous efficiency and, therefore, maximum power saving, while respecting the luminous flux determined in the design phase.

SPECIAL VARIANTS - on request

CHROMATIC YIELD ≥90 - COLOUR TEMPERATURE ON REQUEST
 VERSION WITH POLYCARBONATE DIFFUSER FOR HACCP ENVIRONMENTS (IP54)

ACCESSORIES - included



SD RADIO / 1 -10V INTERFACE

SD



SMART DIMMER LIGHT SENSOR

Order Code **15039**

SD



VANDAL-PROOF SCREWS



GONIOMETRIC BRACKET









M20 CABLE GLAND WITH VENT VALVE

NEXT >

FH-M

lighting

ACCESSORIES - to be ordered separately



	MOUNTING BRACKET FOR ELECTRIFIED BAR Order Code 12659		CEILING MOUNTING BRACKET Order Code 12664
	POLE END CAP 2X 60-76 Order Code 12661		POLE END CAP 4X 60-76 Order Code 12662
	HIGH BAY LIGHT SUSPENSION CABLE Order Code 12663		PROTECTIVE GRID Order Code 12657

BUILDING AUTOMATION - to be ordered separately

	LOGICA SD LGFM CONTROL UNIT Order Code 21102		BUILDING AUTOMATION RADIO TRANSMITTER Order Code 20104
---	---	--	---

LUMINAIRE + EMERGENCY WITH PRE-WIRED LED INVERTER - modular coding

SD

BUILT-IN INVERTER	SUFFIX	EMERGENCY SYSTEM	BATTERY	AUTONOMY (h)	LED POWER (W)
	TR1	STANDARD	NiCd 7.2V 0.75Ah	1	3
	TR3	STANDARD	NiMH 7.2V 1.5Ah	3	3
	ATLG	AT-LG	LiFe 9.6V 1.5Ah	0.75/1/2/3/8	9/7/4/2/1
	LGFM	LGFM	LiFe 9.6V 1.5Ah	0.75/1/2/3/8	9/7/4/2/1
	ATLGGL	AT-LG	LiFe 12.8V 1.5Ah HT	0.75/1/2/3/8	15/10/5/3.3/1.25
	LGFMGL	LGFM	LiFe 12.8V 1.5Ah HT	0.75/1/2/3/8	15/10/5/3.3/1.25

LUMINAIRE + EMERGENCY WITH PRE-WIRED LED INVERTER - modular coding

RD

BUILT-IN INVERTER	SUFFIX	EMERGENCY SYSTEM	BATTERY	AUTONOMY (h)	LED POWER (W)
	TR1	STANDARD	NiCd 7.2V 0.75Ah	1	3
	TR3	STANDARD	NiMH 7.2V 1.5Ah	3	3

Each unit in this series can be **configured and pre-wired directly in Beghelli**, ready for installation.

For orders, create the code by specifying the control system using the following tables:

Order Code LUMINAIRE + SUFFIX, for example, to order an Autotest Logic GranLuce (AT-LG) 110W FH-M floodlight, add to the Order Code 40810 the ending ATLGGL = Order Code 40810ATLGGL